

# T-18 NEWSLETTER



*Mac Booth and his Thorp T-18  
he's from Daleville, AL  
a very familiar face at our events.*

## IN THIS ISSUE:

**Oshkosh 94**

**Building a fiberglass dash cover**

**Thorp T-18 Mutual Aid Society Membership List**

## Upcoming Events

**Kentucky Dam Oct 7-9**

**Placerville, CA Sept 23-25**

*NOTICE: (STANDARD DISCLAIMER) As always , in the past, present, and future newsletters, we would like to make you aware that this newsletter is only presented as a clearing house for ideas and opinions, or personal experiences and that anyone using these ideas, opinions, or experiences, do so at their own discretion and risk. Therefore, no responsibility or liability is expressed or implied and is without recourse against anyone.*

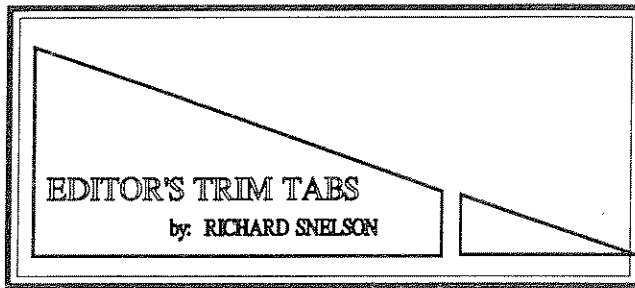

To our Members:

I've included the latest membership list in this newsletter, because, I believe that only through our sharing of knowledge and acting as mentors, for new builders, will we keep the T-18 adventure alive. Use the list to find someone that lives near you. Give him a call and ask if he is building, flying or just thinking about it. If you can, go see their project, better yet, take them for a ride in your T-18. Believe me, this will get a stalled project going again.

Our Kentucky Dam fall gathering, October 7-9, is nearly here. Call now and make your reservation. This event is the best time to share building and flying experiences with our new members. We have a great fellowship of old friends, and want to welcome and open our minds and cockpits to the new members wanting to learn about and build their own Thorp T-18. Drive to this event folks, even if you can't fly. We promise a great time and many opportunities to ride in a Thorp T-18.

Sept 23-25 is the 3rd annual Placerville Fly-In. I hope you get this newsletter in time to know about this event. I did send Hal Stephens a membership list, earlier, so he could send out a special mailing about it. Call either Hal Stephens at (408) 365-8836 or Jim Critchfield at (916) 621-1584 if you plan to attend.

Future articles for the newsletter include: Cleveland Brake Maintenance, the list of T-18 drawings, Mark Landoll's Harmonic Dampener for Lycoming Engines, and Installing a Navaid Devices Auto Pilot. We still need your articles on building and flying the T-18, so please continue

to write and send articles.

Congratulations to Coyt Johnston of Snyder, OK he flew his T-18 for the first time. He is having a fly-in on October 22, 1994 and we are all invited. Let him know if you plan on attending. His phone number is 405-569-2895.

And finally, I didn't forget the Flying Nut Contest Winners. I promise to get the Don Taylor T-18 parts off to those of you contributing articles soon.

Rich

## Oshkosh 94

Call it Oshkosh jitters - I was not looking forward to flying into Whitman Field again, after the crazy traffic encountered on my trip last year. Being wiser, I didn't go a day early like everyone else. Instead, I waited until Thursday, the first day. Leaving Decatur, IL early, we were over Ripon in 1hr. and 45 mins with only one airplane in sight, in front of us. We had guessed correctly the field was closed except for inbound show planes. It was simply follow the railroad tracks and then a close in base to final turn. The controller had time to comment, "Good job by the Thorp". We all have to get lucky once in a while and set it smoothly on the numbers. Not like last year when our clearance to land was; "You guys just keep coming you're doing fine" and my landing wasn't crisp.

With more luck, I managed to get a parking spot near the end of a row in the general area of the long established T-18 parking. The ground crews were letting RV's take over all the central parking, therefore, pushing everyone else out of the area. With the large number of RV's being completed, in the future, there won't be any parking for other types in the rows 9-11 area. I think we should try to rope out a couple of rows, if some of us get there early next year.

I'm sure the last minute change in the forum date from Tuesday to Thursday resulted in a lot of folks missing it. I'm sorry that happened, and want to explain that, we got the call from headquarters after the newsletter was in the mail. I did like having it on Tuesday, however, since it allowed us to get the T-18 events over before the weekend. In spite of the date change, we had more than 100 people in the tent. I'm never quite sure what to discuss in YOUR FORUM. It is your forum, and you should choose the topics we cover. I've been covering safety concerns in the past and would like to keep that a part of the agenda but need help in selecting other topics. So please send: Suggestions for the forum.

The Friday noon cookout at the Nature Center is my favorite T-18 event. It's a chance to relax and enjoy the company of a lot of old friends. We had a good crowd, a good lunch and a good time. I hope Bob Highley can get the Nature Center again next year. (By the way, we collected too much money and have a surplus toward next year's cookout.)

Our Friday's banquet attendance was good and the crowd enjoyed Lee Skillman doing his usual fine job as master of ceremonies. Thanks Lee! It was especially nice to have Dick Cavin with us at the banquet. Dick has done so very much for all of us by his contribution of writing and getting the newsletters out for so many years. The organization wouldn't be here if not for Dick's efforts. We greatly appreciate your help Dick.

Bob Highley, our T-18 owner and resident Sun-Fun staff member, gave a talk on what it takes to put on a big airshow. It sounded like he needed to get back to Florida right a way, to start work on 95. Right Bob? Our second speaker, serving with short notice, was Don Pridham a member of Don Taylor's, round the world, flight crew. His talk was very interesting, but too short and left us wondering about "the rest of the story." Maybe Mr. Pridham will honor us with that next year.

Again this year, Phil Tucker of Sport Aviation furnished the Thorp T-18 awards. Four new T-18s were flown to Oshkosh 94 and won a copy of Charley-Mike-Charley the book by Clive Canning about his famous T-18 flight from Australia to Great Britain. Our congratulations to the builders; Bill Williams, Earl Ody, Harlo Mckinty and Larry Whetzel. This was really our lucky year since RoxAnne and I brought home the award for the best Thorp T-18 at Oshkosh. This award winner is chosen by the former Wright Brother's award winners and this year we had seven at the fly-in to do the selection. My thanks to those folks for awarding us this honor. I'm sure they had a hard time making a single selection from the large number of fine T-18s on the flight line. The 1994 Wright Brother's Award winners were Ron and Jane Hayes of Blue Springs, Missouri. They were in Dayton just before Oshkosh to receive the award. Congratulation to the Hayes.

The Saturday afternoon airshow brought an absolute mob to the flight line. There were too many people and lawnchairs. A few had no appreciation for the show planes. I saw folks leaning on wings and putting their feet on wheel pants. This gets my dander up real quick. I couldn't take it any longer so we pulled out before the airshow Sunday. It might have been that I really just wanted to get back to flying instead of watching others doing it. Until next year. Good building and flying.

Rich.

## Wanted

Not certain about building, buying or finishing. Will consider buying parts/plans, unfinished project or flying T-18. Please call or write. Don King, 19876 Route 52, Hopewell Jct. NY 12533. (914) 227-5084

## For Sale

Dean Cochran of Broomfield, CO is again supplying exhaust systems. Call him at (303) 466-3472 for details.

# FIBERGLASS DASH COVER

Charlie Brown, a Glasair builder and hanger neighbor insisted that flying a new Thorp T-18 with a piece of black carpet draped across the dash top just wasn't to aviation standards. So with Charlie's instruction on the use of foam and fiberglass, a dash cover project for my "All Metal T-18" was started.

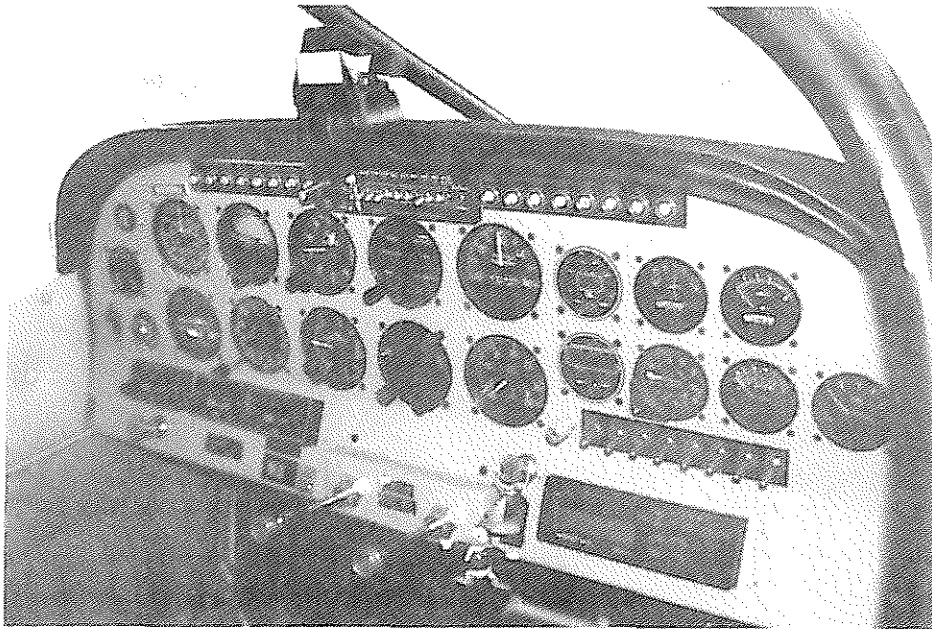

*Note: This article describes the steps to follow in building an attractive lightweight panel top that can be used to house instrument panel lights. Using foam as the core material provides two safety benefits: it will crush in a crash without cutting your head, as aluminum could, and it's an insulator so it won't short out fuses and wiring if, there located at the top of your panel.*

The dash cover is designed, using a sandwich construction, and extends aft over the instrument panel to provide a glare shield for night flying. The overhang is 2 inches thick at the instrument panel, 3 inches long and tapers to a 3/4 inch rounded end. The core material for the cover is Clark Foam. It's a small cell rigid foam that can be bent into position and fixed in shape with an application of fiberglass cloth and resin. The foam is available in 1/4" thick 24x48 inch sheets from Wicks Aircraft's Supply 410 Pine St. Highland, Illinois. Their phone number is (800) 221-9425. Purchasing two sheet will give you some extra material for future projects that may come up.

Using the instrument panel top as a

pattern, cut a 3/4" plywood former to the profile of the top. A second former is then cut to match the curvature at the rear of the top cover. In the T-18 this second former matches the dash bulkhead that is under the front edge of the windshield. Space the formers apart to match the distance your instrument panel is located from the bottom of the windshield and fastened them to a work table using drywall screws (Fig 1). To stabilize the mock-up add two spacers between the formers flush with their tops.

Four pieces of foam are then cut to extend across the width of the instrument panel former and to build up the tapered panel lip. Each one is increased in width by 1 inch. The

first should be 3" wide x 34" long, the second 4" inches etc. to 6". Using a hot glue gun fasten the 3" wide strip to the instrument panel former letting it extend out about 3/4". Just put 3 to 4 spots of glue across the top, so it won't be difficult to remove the top assembly from the former later. The 4" wide foam is glued on top of the previous piece and extends 3/4" out over the edge of it. Use more glue here as we want the two pieces to stay together permanently. Continue the process for the other two foam pieces building up the front edge height and sloping profile.

is soft and will shape easily. I have a compass hanging down from the windshield center post right into the dash top center. So an addition cut out was necessary in the top to allow for the compass. Again coat the cut-out with resin to seal it. Complete the fiberglass foam sandwich by painting the underside and edges with resin. You won't need any glass cloth here as the assembly is strong and will hold its shape without it.

Before covering the top trim and fit the cover to the airplane. Since my instrument panel is supported at the top by two shock mounted brackets in just the right location, and the top is very light, two long # 8 screws through the top into two Rivnuts in the brackets will hold it in place. Just let it float at the back. It should just extend up to and under the windshield flange without touching it.

To cover the top use a non-reflective naugahyde for the front edge. Start by gluing (3M Upholstery

Figure # 2

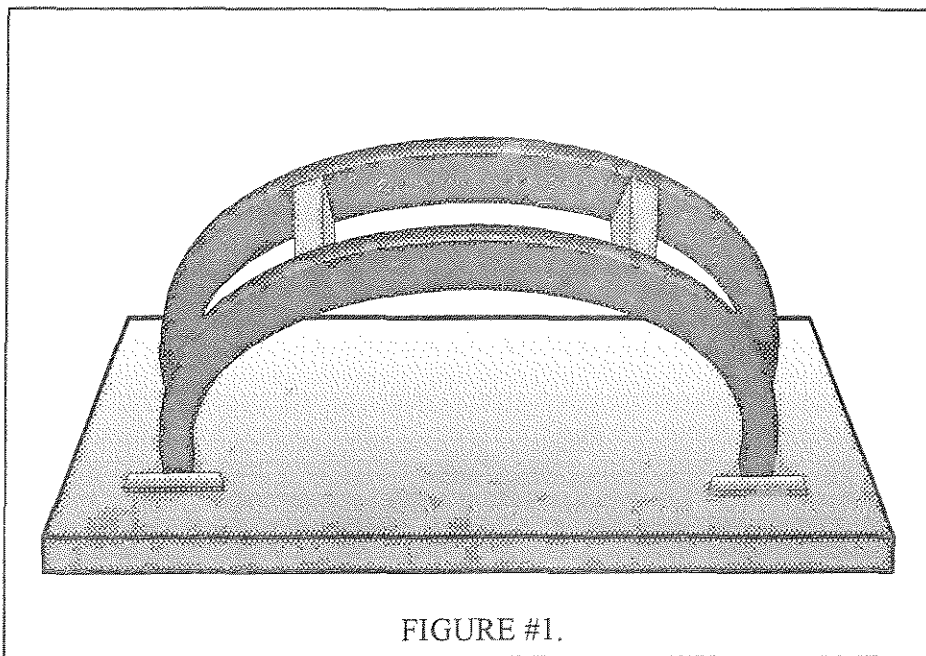

A single piece of 1/4" foam is then used to cover the build up and extend to the windshield former. But first it's necessary to profile the sides of the build up for the top to lie in place without gaps. Fig. #2 shows the panel side profile after the pieces are attached and cut to shape. Using a sharp knife do the rough profile shaping and then finish with a rasp or Stanley Surform Plane. Test fit the top cover sheet as you proceed with the trimming. If you're satisfied with the fit, hot glue the top in place. Cut one more strip of foam 3/4" wide and glue it to the top front edge of the whole assembly. Using a rasp or sandpaper round this piece over on the front and back edges. Don't trim the top cover at this time as it will be done after the assembly is removed from the formers before it is covered.

The next step is to seal and fix the foam shape by applying fiberglass and resin to the top. First a coat of either Polyester or Epoxy Resin is applied to the top surface. After it

cures knock off any rough spots with sandpaper and cut a piece of fiber glass cloth to extend from the back edge of the 3/4" inch rounded strip to the windshield end of the panel. Trying to get the cloth to lay down over the 3/4" front edge and across the flat top at the same time is impossible and isn't needed anyway so don't bother. Wet the surface of the top with the resin and lay the cloth in place. Brush on additional resin as needed to fully wet the fiberglass. Allow the assembly to cure over night and then remove it from the forms, being careful not to tear it at the glue spots.

Using a rasp shape the profile of the underneath front edge to a nice taper and round the front edge. The material

Cement) and stapling one edge of the material across the top just behind the 3/4" strip. A heavy duty hardware store stapler is best for this. Starting at the center the material is stretched over the front edge and over the tapered bottom front. Pull it tight at the center and glue and staple it working out from the cen-

ter. Working carefully the material will stretch and cover the edge without any wrinkles. Cut around the compass cut out and cover it separately. To complete the top covering glue on a non-reflective carpet or upholstery material.

the idea and method used to make a light weight good looking dash cover for my all most all metal Thorp T-18. By changing the shape and size of the forms this dash cover method should work for any aircraft type. Good luck!

My thanks to Charlie Brown for

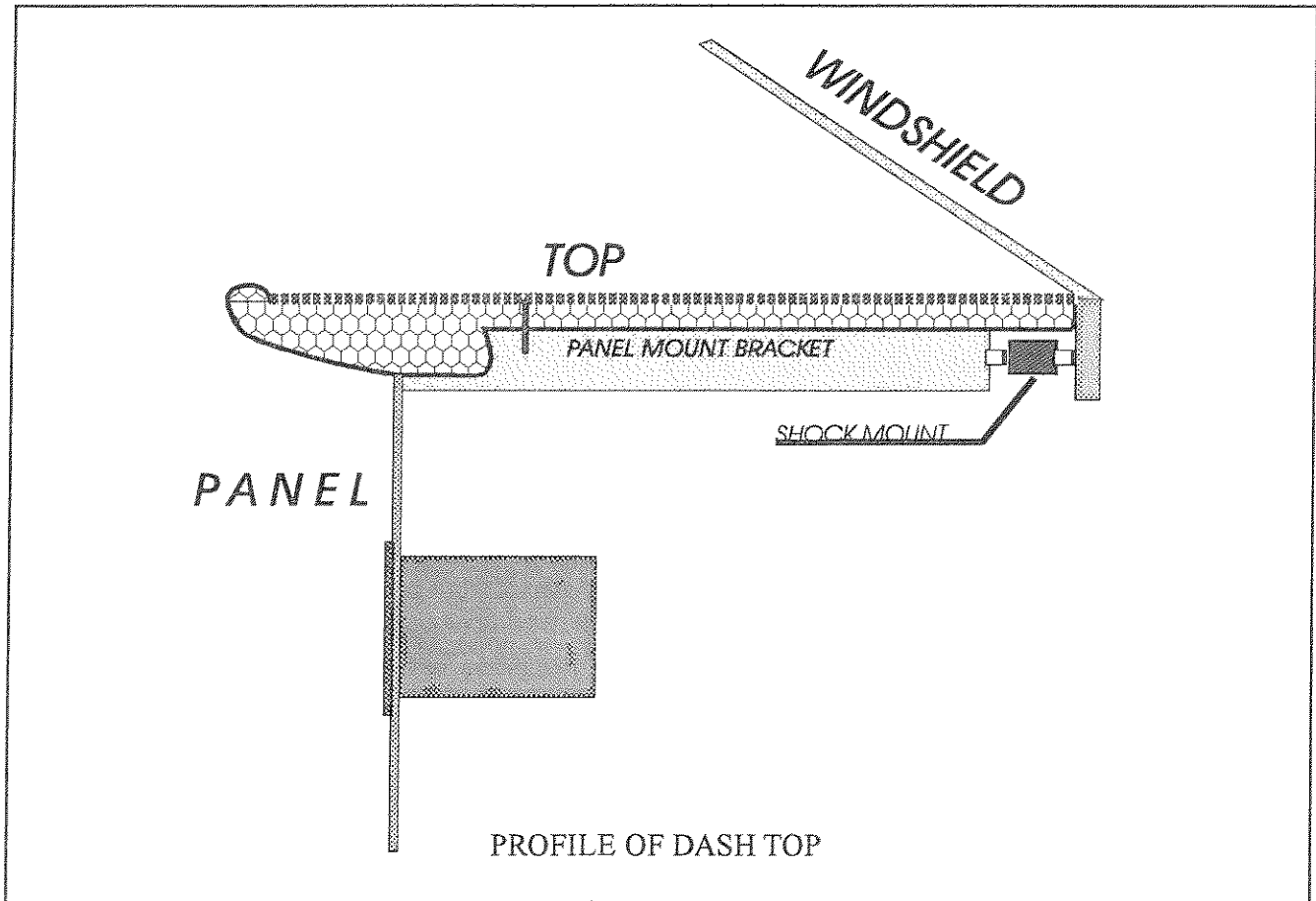

Material List

- 2- Sheets of Clark Foam 24x48
- 4 Sq ft of fiberglass cloth
- 3 ozs. of resin
- 10" x 40" of black carpet
- 10" by 48" of black Naugahyde for the front edge
- Mounting hardware

Tools

- Jig saw or bandsaw
- Sharp knife
- file or rasp
- sandpaper

# FIRST FLIGHT

FOR COYT JOHNSTON

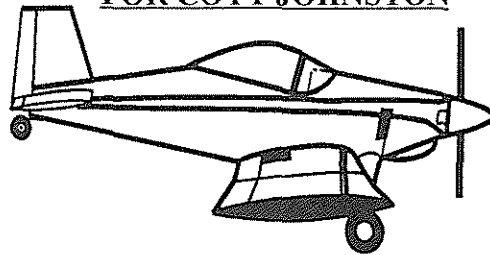

I FINALLY FLEW N-160CJ ON THE 16 DAY OF THIS MONTH. I DID NOT HAVE MY TRIMS FOR WAITING ON THE CONTROL GRIPS AND WAS READING THE NEWSLETTER SUNDAY NIGHT WHERE JOHN GOT THE T-18 APPROVED LESS A TRIM INDICATOR DUE TO IT BEING LIGHT ON THE CONTROLS. AFTER GETTING DUAL FROM GARY GREEN AND DAVE EBY AT McALISTER I FELT I NEEDED SOME TAXING PRACTICE ON MONDAY. TAXIED TO THE NORTH END OF MY RUNWAY, NO PROBLEM THEN TAXIED BACK SOUTH INTO THE WIND RAISED THE TAIL,(JUST FOR TAXI) IT FELT SO GOOD I RELAXED FORWARD PRESSURE AND IT LIFTED OFF. IT FLEW GREAT. THE ONLY PROBLEM I HAD WAS GETTING IT SLOWED DOWN FOR LANDING. I THINK MY A.S. IS SLOW ABOUT 20 MPH. LANDED GREAT AFTER SLOWING. I AM SOLD ON THE T-18 AS ALL SEEM TO BE. I HAD DOUG RIPLEY FROM WITCHITA FALLS FLY IN SUNDAY MAY 29, HE FLYS JOHN SIMMONS AND DAVE'S T-18, BE FLEW 160CJ ABOUT 30 MINUTES, DID STALLS AND ROLLS SAID IT WAS A GOOD ONE.

I STILL LIKE A FEW LITTLE ITEMS HAVING IT READY FOR PAINT BUT IT WILL FLY FOR A WHILE WITHOUT PAINT.

I WANT TO THANK GARY AND DAVE FOR THEIR HELP WITH DUAL IN THEIR T-18S, IT WAS A GREAT HELP.

I AM ENCLOSING A FLIER FOR OUR FLYIN IN OCTOBER INCLUDE IT IN THE NEWSLETTER IF YOU LIKE. WE WOULD LIKE TO HAVE A FEW T-18 HERE.

(keep up the good work on the newsletter. its a great help to have somewhere to go when you stump your toe)

SINCERELY  
COYT JOHNSTON

RT. 1 BOX 178 SNYDER, OK. 73566

*Editor's Note: I ran out of space and couldn't include the flyer. The date is Oct 22. More details in the editors column.*

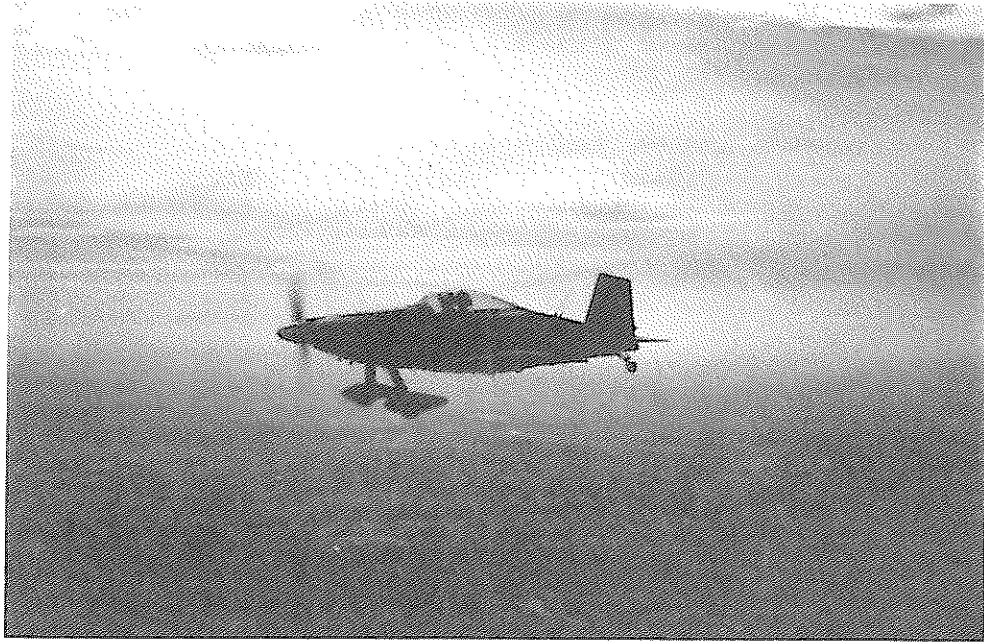

## T-18 FALL GATHERING KENTUCKY DAM VILLAGE STATE RESORT PARK

The Fall 1994 T-18 weekend at Kentucky Dam Village State Resort Park will be held on October 7-9. The private dining room has been reserved for Sat. Oct. 8, at 7:00 PM. We will again use the buffet.

**MAKE YOUR RESERVATIONS WITH THE PARK DIRECTLY. YOU MUST SPECIFY YOU WANT THE PAINE PARTY IN ORDER TO RECEIVE THE QUOTED RATES.** THE LODGE MAY BE FULL OTHER THAN THE ROOMS THEY ARE HOLDING FOR OUR PARTY AS WE HAD TROUBLE GETTING RESERVATIONS THIS YEAR. RESERVATIONS MUST BE MADE BEFORE SEPTEMBER 7, 1994.

RATES ARE: \$46.40 (single) \$55.68 (double)

**KENTUCKY DAM STATE PARK  
P.O. BOX 69  
GILBERTSVILLE, KY 42044  
1-800-325-0146**

Camping is also available on a first come, first serve basis as well as cottages. Contact the resort for information.

Kentucky Dam State Park Airport is 30 miles east of- the Cunningham VOR (Paducah) on the 90 degree radial, 8 miles south of V178. The runway is paved, 4,000 feet long. The Airport is approximately a mile from the resort, however transportation is available for those who do not wish to walk.

**BRING YOUR OWN TIE-DOWNS.**

**Note: If the lodge is full, there is a Ramada Inn at Kentucky Dam, not far from the airport.**



# Thorp T-18 Mutual Aid Society

BOB AFFLECK  
BOX 745,  
HARROW ONT NOR-1GO

BILL AIRIS  
6416 E. MERCERWAY,  
MERCER ISLAND,WA 98040  
206-232-8710

JOSEPH ALT  
ROUTE 1, BOX 144  
WOLBACH, NB 68882  
308-246-5510

DICK AMSDEN  
20704 BIRCH MEADOW DR.  
CLINTON TWP, MI 48036

THOMAS B. ANDERSON  
P.O. BOX 214950  
DALLAS, TX 75221-4950  
214-855-4795

H.B. ARNOLD, III  
4411 CRESTWOOD WAY  
SACRAMENTO, CA 95822  
916-441-0811

JOHN AUSTIN  
RT. 1, BOX 205A  
MCKINNEY, TX 75070  
347-2030

LEWIS AVRAMOVICH  
1962 13TH ST.  
CUYAHOGA FALLS, OH 44223  
216-923-5067

LEN BAKER  
ROUTE 3, BOX 43A  
FALLS CITY, NE 68355

R.D. BAKER  
1626 SHERMAN  
CANON CITY, CO 81212  
719-275-8022

ROBERT BECKLEY  
3772 PARADISE VIEW  
CARSON CITY, NV 89703

RICHARD R. BENDER  
25 AVIATION DRIVE  
WINTER HAVEN, FL 33881  
813-293-2829

ROBERT J. BERNING  
927 S. 2ND. ST  
SPRINGFIELD, IL 62704  
217-525-3438

BILL BERTRAM  
P.O. BOX  
708 HARRISON, MI 48625  
517-539-3333

TONY BINGELIS  
8509 GREENFLINT LANE  
AUSTIN, TX 78759  
512-345-1537

JIM BLAKE  
11400 SHADY LANE  
PLANTATION, FL 33325  
305-475-6737

JAMES BLAKER  
8947 VICKSBURG LA.  
MANASSAS, VA 22110  
703-368-7284

DON R. BLEHM  
P.O. BOX C-182  
GREEN MTN. FALLS, CO 80819

B.R. BOERNER  
4725 ADAMS RD  
DUNWOODY, GA30338-5222  
404-394-8672

MAC E. BOOTH  
P. O. BOX 580  
DALEVILLE, AL 36322  
598-8141

JAMES A. BORG  
15800 MAKAH ST  
ANDOVER, MM 55304

AL BOSONETTO  
32625 BENSON DR.  
WESTLAND, MI 48185  
313-261-6852

BILL BRACKET  
152 NORTH ROAD  
BUTLER, PA 16001  
412-287-5804

RICHARD F. BRANDIGER  
R.R. 8,  
RAPID CITY, SD 57702  
341-3417

KEN BROCK  
11852 WESTERN AVE.  
STANTON, CA 90680  
714-898-4366

MAURICE BROOKS  
1608 CASA CT  
ALVIN, TX 77511  
388-2301

DON BROUSSARD  
500S. FRENCH QUARTER DR.  
HOUMA, LA 70364  
504-851-1888

ROBERT P. BROWN  
432 E. CALLE BONITA  
SANTA MARIA, CA 93455  
805-928-5431

JERRY BRUECKNER  
9854 E. AVE S-6  
LITTLEROCK, LA 93543  
805-944-6061

DON BUCHANAN  
2543 BELLEVUE AVE  
BETTENDORF, IA 52722  
319-355-6201

NICKY BUCHANAN  
PO BOX 11334  
ROCK HILL, SC 29731  
803-366-1513

JOHN BUFFINGTON  
3618 LANCASTER RD.  
ERIE, PA 16506  
814-838-9861

RAYMOND W. BUNDSCHUH  
AMERICAN EMBASSY -K.L.  
APO AP 96535

ED BURKE  
250 FRANKLIN DR.  
PITTSBURGH, PA 15241  
412-941-8760

DONALD L. BYRNE, JR.  
16 TAMMIE DRIVE  
BEAR, DE 19701  
302-834-9474

WALT CANNON  
2332 N 64th ST  
SEATTLE, WA 98103  
206-524-7221

J. E. CARLISLE  
1110 EAST MARKS STREET  
ORLANDO, FL 32803  
407-898-5111

SAMUEL W. CARSON  
265 EUTAW FOREST DR.  
WALDORF, MD 20603  
301-843-1828

JAMES CASH  
1125 GREEN LEAVES DR.  
GRANBURY, TX 76048  
817-573-7766

RICHARD CAVIN  
10529 SOMERTON DR  
DALLAS, TX 75229

ADEN BRAD CHAPMAN  
17505 NE TERRY'S LANE  
NEWBERG, OR 97132-6722  
503-538-7316

GARY CHENIER  
3702 REBEL DR  
DEFOREST, WI 53532  
837-2557

ALLAN S. CHIVERS  
4465 ODEN BAY DR.  
SANDPOINT, ID 83864-9447  
208-263-4618

MEL CLARK  
6561 HALIFAX  
HUNTINGTON BEACH, CA 92647  
714-897-3370

ROBERT CLAYTON  
1783 HARVARD AVE.  
SALT LAKE CITY, UT 84108  
801-582-5398

DEAN COCHRAN  
255 HEMLOCK  
BROOMFIELD, CO 80020  
303-466-3472

HOWARD COLLINS  
110 E. 25TH AVE  
SAN MATEO, CA 94403  
415-358-9036

THEODORE CONRAD  
117 LAS LOMAS DR.  
SAN ANGELO, TX 76904  
915-949-1474

LESLIE C. CONWELL  
1725 OAKWOOD CT.  
LUTZ, FL 33549  
813-920-2931

GEORGE COPLAND  
ROUTE 2, BOX 12  
DUNCAN, OK 73533

LEO J. CORBALIS  
2998 VIA DEL SOL  
SAN JOSE, CA 95132  
262-5734

GARY M. COTNER  
13715 N. 150TH EAST AVE.  
COLLINSVILLE, OK 74021  
918-371-4739

ALFRED COUSINEAU  
8332 N. OCTAVIA  
NILES, IL 60714-2627  
708-967-7432

JOHN CRAGIN  
160 STRATFORD ROAD  
NEEDHAM, MA 02192  
617-444-3105

JAMES C. CRITCHFIELD  
1579 SEAN DRIVE  
PLACERVILLE, CA 95667  
916-621-1584

GENE A. CROCKETT  
961 GENEARE WAY  
MILFORD, MI 48381  
810-685-1161

JOHN CROOK  
804 LEADING LANE  
ALLEN, TX 75002  
214-727-1804

PAUL H. CROZIER  
8016 OAKWOOD FOREST DR.  
HOUSTON, TX 77040  
713-937-4202

DANNY CUMMINGS  
600 W. MAIN  
McMINNVILLE, TN 37110  
615-473-5401

BEN CUPP  
ROUTE 1, BOX 300  
YELLEVILLE, AR 72687  
501-436-5618

GERALD CZARNIAK  
4536 W. NORWICH AVE.  
GREENFIELD, WI 53220  
414-541-0318

GEORGE T. DANIELS  
1132 RIVERSIDE TRACE  
SUGAR HILL, GA 30518  
299-6750

EDWARD DANIELSEN  
5726 CLEARSITE  
TORRANCE, CA 90505-3256  
310-332-6950

EDWIN DARBY  
1290 BOARD SHANTY RD.  
GRANTS PASS, OR 97527  
503-862-2074

CARL DAUGHTERS  
232 ROBLES RD.  
ARROYO GRANDE, CA 93420

ROGER M. DERBY  
6474 FORTUNE ROAD  
FT. WORTH, TX 76116  
817-377-3613

CORKY DOWNER  
P.O. BOX 561  
MT. VERNON, TX 75457  
903-588-2773

DON DOWNIE  
PO BOX 3758  
KINGMAN, AZ 86402

DAN DUDASH  
4641 CARTWRIGHT  
NORTH HOLLYWOOD, CA 91602  
815-980-8145

ERIC DURIS  
28 CLOVER HILL  
STAFFORD, VA 22554

N. L. EASTMAN  
800 E. 6TH ST.  
KIMBALL, NE 69145  
308-235-3202

DAVE EBY  
3206 MARTIN BLVD.  
WICHITA FALLS, TX 76308  
817-766-2523

EDDIE EILAND  
1350 THUNDERBROOK  
DE SOTO, TX 75115  
214-230-8266

PAUL EJBANKS  
157 BAXTER RD.  
PUEBLO, CO 81006  
948-2390

RICHARD C. EKLUND  
BOX 1510  
LOCKEFORD, CA 95237  
209-727-0318

L.H. ELFRINK  
751 DUKE DRIVE  
ALAMOSA, CO 81101  
589-3024

ERNEST ESTEFAN  
1414 W. JACKMAN  
LANCASTER, CA 93534  
805-948-5689

JAMES W. EVANS  
12108 SW 148TH ST  
VASHON, WA 98070  
206-567-4765

JOHN R. EVENS  
6855 ALLISON STREET  
ARVADA, CO 80004  
420-2724

LARRY D. EVERSMEYER  
10721 EASTLAKE CIRCLE  
OKLAHOMA CITY, OK 73162

ROY A. FARRIS  
BOX 182  
NOBLE, IL 62868  
618-723-2594

STEPHEN J.FIZET, JR.  
3437 MCDONALD AVENUE  
GIRARD, OH 44420  
530-3312

JACQUE FLETCHER  
#103, 877-64 AVENUE NW  
CALGARY, ALBERTA, CANADA T2K5J4

EUGENE J. FODY  
4925 ZELZAH AVE  
ENCINO, CA 91316  
818-343-8001

MELVIN FOLKERTS  
1767 150TH ST.  
RUDD, IA 50471  
515-395-2732

TOM FORSYTHE  
8766 MARCEL CADIEUX  
MONTREAL QUEBEC H2M2L1

DAVID FOX  
5100 HARRIET AVE  
MINNEAPOLIS, MN 55419

DOUG FRANTZ  
1019 S. MEADOW LANE  
MUSTANG, OK 73064  
405-376-4492

JAMES W. FRENCH  
6711 CHEROKEE AVE  
FORT MYERS, FL 33905  
813-694-4240

JOHN FREW  
3328 SANDHURST RD  
BIRMINGHAM, AL 35223-2806  
205-967-3338

ROBERT FURRER, M.D.  
590 COUNTRY CLUB RD  
EUGENE, OR 97401  
503-687-2424

LEONARD GAINES  
2327 RUE DE CHARLENE  
RANCHO PALOS VERDES, CA 90274  
310-833-1007

WM. R. GARDNER  
1308 MADISON ST.  
ALICE, TX 78332  
512-664-6364

JOE GAUTHIER  
9 KOWAL DRIVE  
CROMWELL, CT 06416  
203-635-4058

CHARLES GEORGE  
14287 POLK ST  
SYLMAR, CA 91342

ROMAND GERRARD  
2874 NORTH 6TH ST.  
SPRINGFIELD, OR 97477  
503-746-0452

WALT C. GIFFIN  
419 S. FAIRWAY DRIVE  
PUEBLO WEST, CO 81007  
719-547-2906

FRED GINDL  
5515 TREMAINE RD.  
MILTON,ONTARIO,CANADA L9T 2X5  
416-876-2038

ANTHONY E. GINN  
4400 STETSON AVE  
ROSAMOND, CA 93560  
805-246-4829

HOWARD GINN  
8436 PROSPECT ST.  
MOJAVE, CA 93501  
805-824-3140

GARY GLEFFE  
P.O. BOX 177  
DEER PARK, CA 94576  
707-965-3606

DAVID V. GOFF  
3442 PUTNAM ROAD  
ST. AUGUSTINE, FL 32086  
904-797-6046

PETE GONZALEZ  
1318 SERVER DR.  
COLORADO SPRINGS, CO 80910  
719-634-6358

DAN MCGREW  
125 N. SMITH AVE  
TUCSON, AZ 85704

HARLO MCKINTY  
101 RAINBOW DRIVE. #1697  
LIVINGSTON, TX 77351  
602-983-5363

T. McLAM  
4 DEBBIE LANE  
WESTHAMPTON BEACH, NY 11978-2060  
516-288-7054

KIM NACK  
2940 DEVONSHIRE DRIVE  
FLORISSANT, MO 63033-1320  
314-839-3873

PAUL NATHO  
P.O. BOX 26918  
AUSTIN, TX 78755  
512-346-7004

DAVID NEUSTEL  
1045 SUNFISH DR  
MANTECA, CA 95337  
209-823-0625

JOHN O'KEEFE  
13630 BEL AIR DRIVE  
VICTORVILLE, CA 92392  
619-245-0960

EARL ODY  
28903 GUNTER RD  
SAN PEDRO, CA 90732  
310-833-6872

BOB OLDS  
2207 WILKES AVE  
DAVENPORT, IA 52804

BRIAN OLNEY  
28 BRIAN AVE  
W. AUSTRALIA 6153  
09-364-2120

DEAN OLSON  
PO BOX 177  
HUDSON, IL 61748

JAMES G. PAINE  
4240 WAGNER ROAD  
DAYTON, OH 45440  
513 426 9671

BOB PARK  
16911 MT. ROSE HWY  
RENO, NV 89511  
702-849-9206

CHARLES R. PATTON  
21490 CAMINO ARRIBA  
MURRIETA, CA 92562

NORMAN W. PAUK  
608 S. 152ND ST. APT B3  
BURIEN, WA 98148  
244-9362

BARRETT L. PAYNE  
4618 BURNET ROAD  
AUSTIN, TX 78756  
454-5671

RICHARD PENMAN  
5918 BORDMAN ROAD  
DRYDEN, MI 48428  
810-628-5075

ALBERTO PEREIRA  
3615 CAPISTRANO TRAIL  
AUSTIN, TX 78739  
512-282-2871

BOB PERNIC  
86 DARTMOUTH RD  
WILLIAMS BAY, WI 53191  
414-245-6445

J.W. PERRINE  
2722 MILITARY RD  
JACKSONVILLE, AR 72076  
501-985-6437

DAVID PETRO  
BOX 14  
BENEDICT, NE 68316  
402-732-6725

G.M. PINKSTON  
8567 SAN LEANDRO  
DALLAS, TX 75218

SVEN-ERIK PIRA  
STROMSVAGEN 29 S-83300  
STROMSUND, SWEDEN

ED POE  
402 EAST BRAEBURN DRIVE  
PHOENIX, AZ 85022  
602-942-8500

ROBERT W. POEHNER  
607 AMOS ROAD  
SHELBYVILLE, IN 46176  
317-398-9985

CLARK POLINSKI  
13421 BRAINARD  
CHICAGO, IL 60633

ARVIL M. PORTER  
2200 SUTLER LANE  
MILTON, FL 32570  
208-683-3126

RANDALL L. PORTER  
P.O. BOX 212  
ATHOL, ID 83801-0212  
208-683-3126

JEFFREY PULS  
1635 HINER ROAD  
ORIENT, OH 43146

JIM PUTNEY  
1707 W. LAVENDER LN  
ARLINGTON, TX 76013  
817-274-1083

KENNETH RANTA  
9805 P CIR.  
OMAHA, NE 68127  
402-593-9492

CLIFTON REDDEN  
8774 AIRPORT RD  
GEORGETOWN, OH 45121  
513-378-6604

PAUL E. RENDEL  
2684 LINDENWOOD DRIVE  
PITTSBURG, PA 15241  
412-835-2974

JAMES H. RENNEKER  
4147 26TH AVENUE SOUTH  
MINNEAPOLIS, MN 55406  
612-724-6735

KEN RHOADS  
175 HICKORY LANE-FAR HILLS  
EAST PEORIA, IL 61611  
309-699-2039

LOUIS RIEKERT  
3913 ECUADOR CIRCLE  
PASADENA, TX 77504  
713-941-7432

EVAN A. ROBERTS  
RT. 5 BOX 158C  
TEMPLE, TX 76501  
817-778-2252

LEON ROBERTS  
832 CALLE PRIMAVERA  
SAN DIMAS, CA 91773  
909-599-9569

B. C. ROEMER  
TRUEFLIGHT BOX 1000  
MANITOWISH WATERS, WI 54545  
379-2439

GERALD F. ROMEO  
32 KOMAR DR.  
BALLSTON LAKE, NY 12019  
518-399-8386

FRANK RONCELLI  
4118 WEST L4  
LANCASTER, CA 93536

GARLAND D. ROOT  
4216 ASTORIA STREET  
SACRAMENTO, CA 95838  
916-922-5070

RUSSELL ROSS  
BOX 411, RR #1  
SIOUX CITY, IA 51108  
239-5681

BRYANT ROWLAND  
6703 GENERAL CUSTER  
WICHITA FALLS, TX 76310  
817-692-9089

DONALD F. RUFFNER  
8 UPTON LN  
YARDLEY, PA 19067

CHARLES M. RUSSELL  
10992 HWY 133  
CASSVILLE, WI 53806-9606

ROBERT V. RYAN  
BOX 954  
SEELEY LAKE, MT 59868  
406-677-3117

DARRON J. SANCHEZ  
4462 ST KATHERINE AVE  
BATON ROUGE, LA 70805

ROGER SAUNDERS  
1370 THOMPSON  
GLENDALE, CA 91201  
818-246-9371

WILLIAM SAUNDERS III  
2376 HOLLY LN  
ORANGE PARK, FL 32073  
269-1366

DWIGHT SCAGGS  
3182 WESTBORO RD  
BLANCHESTER, OH 45107-9506  
513-783-2241

**Please add these names to the membership list. A computer transfer program omitted them and I didn't catch the mistake in time to stop the printing press. Sorry about that!**

ROBERT W. HIGHLEY, JR.  
2919 DEERBROOK DR.  
LAKELAND, FL 33811

A.C. HILL  
4106 QUEENSBURY  
HYATTSVILLE, MD 20781

JAMES HOCKENBROCK  
R.D. 1, BOX 361-A  
REEDSVILLE, PA 17084

LEROY HOLT  
BOX 238  
SAVANNA, OK 74565

CURTIS HOPKINS  
11537 JESSICA LANE  
LAKESIDE, CA 92040

JACK W. HULL  
322 MEUSE CT.  
BLUE GRASS, IA 52726

WALLACE G. HUNT  
1658 PLAZA DR.  
ROCKFORD, IL 61108

ELMER HYMEN  
36 CENTER STREET  
MIDLAND PARK, NJ 07432

GARY JACKSON  
P.O. BOX 69  
SIMMS, TX 75574

BOB JAEGER  
603 RUSTIC ROOK  
SOMONAUK, IL 60552

COYT E. JOHNSTON  
RT. 1 BOX 178  
SNYDER, OK 73566

RICK JONES  
550 WINDY LANE  
CEDAR HILL, TX 75104

SCOTT KELLER  
27 HAWTHORNE VILLAGE  
CONCORD, MA 01742

BARRETT KEMP  
434 WAKEROBIN  
RUSSELLVILLE, AR 72801

JACK KENTON  
FAA, PSC#5 P.O. BOX 4309  
APO AE 09057

TOM KERNS  
7033 AUTUMN TERRACE  
EDEN PRAIRIE, MN 55346

PHILLIP KEY  
251 LATHROP SUITE A  
SACRAMENTO, CA 95815

RICHARD C. KEYT  
F. ACH. MD841  
P.O. BOX 619617  
DALLAS / FT. WORTH AIRPORT, TX  
75261-9617

DONALD R. KING  
1876 ROUTE 52  
HOPEWELL JUNCTION, NY 12533

PAUL KIRIK  
3527 13TH ST.  
MOLINE, IL 61265

STEVEN P. KIRIK  
5039 EAST RIDGE DR.  
WICHITA FALLS, TX 76302

JEFFREY KLOSSNER  
7349 CTY RD. 111  
SALIDA, CO 81201

GARY D. KNAPP  
8234 W. HIERBA RD.  
AGUA DULCE, CA 91350

ROBERT L. KOEPP  
1380 SUNNY HEIGHTS ROAD  
FALLBROOK, CA 92028

JOSEPH L. KROUPA  
505 TWINNING DR.  
DAYTON, OH 45431

LES KRUMEL  
P.O. BOX 1115  
CEDAR CREST, NM 87008

DAVID R. L'HEUREUX  
23224 DALBEY DR.  
VALENCIA, CA 91355

MARIO LA POMA  
P.O. BOX 777  
FRANKLIN NC 28734-0777

RICHARD D. LAHTI  
4720 CROWN AVENUE  
LA CANADA, CA 91011

EDWARD C. LAMBERT  
2166 FARRINGTON DR.  
EL CAJON, CA 92020

EDWIN H. LAYTON  
HCR 80 BOX 60  
WARFORDSBURG, PA 17267

GAYLE LECOUNT  
407 MILL ST.  
GEORGETOWN, IL 61846





DONALD G. SCHINDLER  
23061 OXNARD ST  
WOODLAND HILLS, CA 91367-3232  
818-340-2094

P.M. SCHMITT  
1040 SARATOGA RD. (RT50)  
BALLSTON LAKE, NY 12019  
518-885-4582

BEN SCOLA  
315 W HAVEN DR  
ARLINGTON HEIGHTS, IL 60005  
708-437-7153

DAVE SEAWELL  
53 CIRCLEVIEW DR.  
LEXINGTON, SC 29072

CRAIG SHEELY  
BOX 38 MANILA, UT 84046  
801-784-3201

NICHOLAS SHEWALTER  
4250 NEW LOTHROP RD.  
CORUNNA, MI 48817  
313-638-5822

MRS. PAUL SHIFFLET  
RT. 2 BOX 44  
EARLHAM, IA 50072  
515-758-2621

TOM SHOCK  
22 2ND SW  
CUT BANK, MT 59427  
406-873-5377

CHARLES W. SHUSTER  
1019 NORTH CLIFTON  
PARK RIDGE, IL 60068  
708-692-2432

LAWRENCE SILVA  
251 E. BROADWAY  
ATWATER, CA 95301  
209-358-3112

ALEX G. SIM  
4460 KNOX AVE  
ROSAMOND, CA 93560  
805-256-4733

WILLIAM S. SIMPSON  
4306 BRIAR CLIFF DR  
WICHITA FALLS, TX 76309  
817-692-7124

LEE SKILLMAN  
7676 WINDCREST DR  
MOBILE, AL 36695  
205-633-3535

BOB SLAGLE  
39 ROBIN HOOD LN.  
CLUTE, TX 77531  
265-8383

GENE H. SLOAN, JR.  
412 LILLARD ROAD  
MURFEESBORO, TN 37130  
615-893-2152

MARION SMALLWOOD  
RT. 2 BOX 327  
LOWELL, AR 72745  
501-756-6565

J. G. SMITH  
47 SILVER RIDGE RISE NW  
CALGARY, ALBERTA,CANADA T3B 4P6

ROD SMITH  
316 NORTH HAMPTON ROAD  
WILMINGTON, NC 28409

NEIL R. SMOOTS  
159 NAOMI AVE  
SHELL BEACH, CA 93449  
805-773-5108

FRANK SNEDEKER  
5528 231ST AVENUE S.E.  
ISSAQUAH, WA 98027  
206-342-0124

RICHARD O. SNELSON  
RT. 3 BOX 295  
CLINTON, IL 61727  
217-935-4215

JOHN B. STARR  
1120 HALLAMWOOD CT  
LAKELAND, FL 33813  
813-644-4452

HANK STEINGINGA  
45528 NEW TREE  
LANCASTER, CA 93534  
942-3046

HAL STEPHENS  
5286 RAFTON DR  
SAN JOSE, CA 95124  
408-723-0244

JAMES J. STRICKENBERG  
4344 GEM CT.  
ERIE, PA 16504  
814-825-2918

J. L. STUART  
1521 EAST AVALON  
SANTA ANA, CA 92701  
714-543-2331

FLORAN P. SULLIVAN  
11355 36TH PLACE N.  
PLYMOUTH, MN 55441  
612-559-0767

DONALD P. TAYLOR  
5 GREENWAY DR.  
AJO, AZ 85321  
602-387-6736

DAVE TENNANT  
121 PRINCETON PLC.  
LOMPOC, CA 93436  
805-735-3115

BERNARD THALMAN  
2912 OLD GLENVIEW RD  
WILMETTE, IL 60091  
708-251-6959

ERNEST N. THORP  
R.R. 3, BOX 252  
CLINTON, IL 61727  
214-935-5461

H. THURMOND  
853 GRAYMOAT DR.  
MOBILE, AL 36608

RAYMOND F. TILLEY  
56 BALD HILL RD  
LAUNCESTON, TASMANIA AUSTRALIA 7250

JERRY TINDELL  
462 CREEK CHURCH RD.  
PANSEY, AL 36370  
205-899-5971

LESTER TINNIN  
3354 S. FLOWER ST.  
#8 LAKEWOOD, CO 80227  
303-987-0851

BUD TODD  
RT 1, BOX 5  
BYRON, CA 94514  
510-634-1223

TIM TRAVIS  
160 AVIATION DR. N, NAA  
NAPLES, FL 33942  
813-643-0733

TIMOTHY TROYER  
5332 ESTHER AVE  
QUINCY, IL 62301  
217-223-7328

LYLE TRUSTY  
1665 NEWGROVE WEST  
LANCASTER, CA 93534  
805-949-1131

GEORGE F. TRUVER  
727 BLACKTHORNE AVENUE  
EL CAJON, CA 92020

PHIL TUCKER  
1237 E. AVENUE J12  
LANCASTER, CA 93535  
805-949-2312

BRIAN UNDERWOOD  
RR2 BOX 137  
WINDOM, MN 56101-9514

STEVE VAIL  
624 W. CYPRESS  
COMPTON, CA 90220  
310-763-2388

LEE WALTON  
343 CHAMPIONS COLONY III  
HOUSTON, TX 77069

JACK WARREN  
115 DOGWOOD LAKE CT.  
ROSWELL, GA 30076  
404-518-3313

BILL WARWICK  
P.O. BOX 397  
AGUILA, AZ 85320  
602-685-2426

WENZEL WECH  
AM LOBEL 18  
SAARBRUCKEN, GERMANY 66125

THOMAS WEINBERG  
P.O. BOX 1604  
MT. VERNON, IL 62864

HAROLD G. WHEELER  
ONE DANA DRIVE  
GROVELAND, MA 01834  
617-594-9890

LAWRENCE WHETZEL  
15621 CALISTOGA DR.  
RAMONA, CA 92065  
619-788-1787

CYRIL WILLIAMS  
3440 HACKAMORE LN.  
CHICO, CA 95926  
342-5319

TED WILLIAMS  
640 STREET RT. 12 BOX 314  
MANSFIELD, OH 44903  
529-5487

WILLIAM F. WILLIAMS  
1014 BURRIS RIDGE  
LAKELAND, FL 33809  
988-4061

JOHN WINTON  
BOX 84  
PORT MANSFIELD, TX 78598  
210-944-2641

ARTHUR WITZKE  
45731 FERMANAGH DR.  
NORTHVILLE, MI 48167  
313-349-4374

DANIEL L. WOLFE  
860 WILKERSON RD.  
FAIRBORN, OH 45324  
513-864-2781

BOB WOOD  
926 WESTMONT DR.  
HOUSTON, TX 77015  
713-453-6696

DR. HAROLD WOOLF  
320 KNOLLWOODS TERRACE  
ROSWELL, GA 30075  
993-3016

ROBERT YEAKEY  
9729 BELLEWOOD  
DALLAS, TX 75238  
214-348-2947

## For Sale

Thorp T-18, 410TT, 290SMO,  
160HP IO320, 185MPH CRUISE, IFR  
CAPABLE, NAVCOM, ILS, LORAN,  
XPNDR MODE C, ELECTRIC PITCH &  
AILERON TRIM, INTERCOM, FLIES  
GREAT! \$22,500 FAIRBORN, OHIO  
CALL 513, 864-2781



EKLUND ENGINEERING, INC.  
P.O. BOX 1510  
LOCKEFORD, CA 95237  
209-727-0318

JOHN THORP'S PROFESSIONAL PLANS SET FOR  
THE T-18 "New Antique" SPORT PLANE.

THE 30th ANNIVERSARY EDITION INCLUDES:

- 219 BLUE LINE DRAWINGS PRINTED FROM JOHN THORP'S ORIGINAL VELLUMS.
- PLANS STORAGE BOX WITH THORP LOGO
- 2 ORIGINAL "Thorp T-18" LOGO DECALS SUITABLE FOR YOUR COMPLETED AIRFRAME.
- COPY OF "The Spirit of Thorp T-18" MEMORIES BOOK.

Price: \$300\*\*

Plans only - \$250\*\*

Information Package - \$15 (pp)

Thorp #1072, 4" Prop Extension  
Clear Anodize with bushings - \$235\*\*

\*\*includes UPS standard delivery in U.S.A.  
Overseas delivery quoted promptly.

Current Plans Owners - 4"H x 9"W T-18 Logo -\$15 each (pp)

T-18 NEWSLETTER  
ROUTE 3, BOX 296  
CLINTON, IL 61727  
1-217-936-4215  
Issue #92 SEPT 94

Bulk Rate  
U.S. Postage  
Paid  
Permit No. 30  
Decatur, IL.

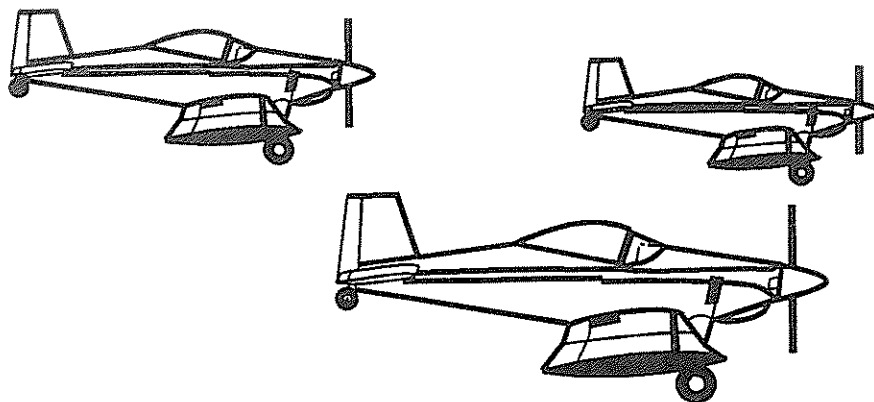

Kentucky Dam Fly-In is Oct 7-9

Placerville 3rd Annual Fly-In is Sept 23-25